

Custom Radiators, Unique Homes

Product Brochure

Brooklyn | Manhattan | London | Manchester

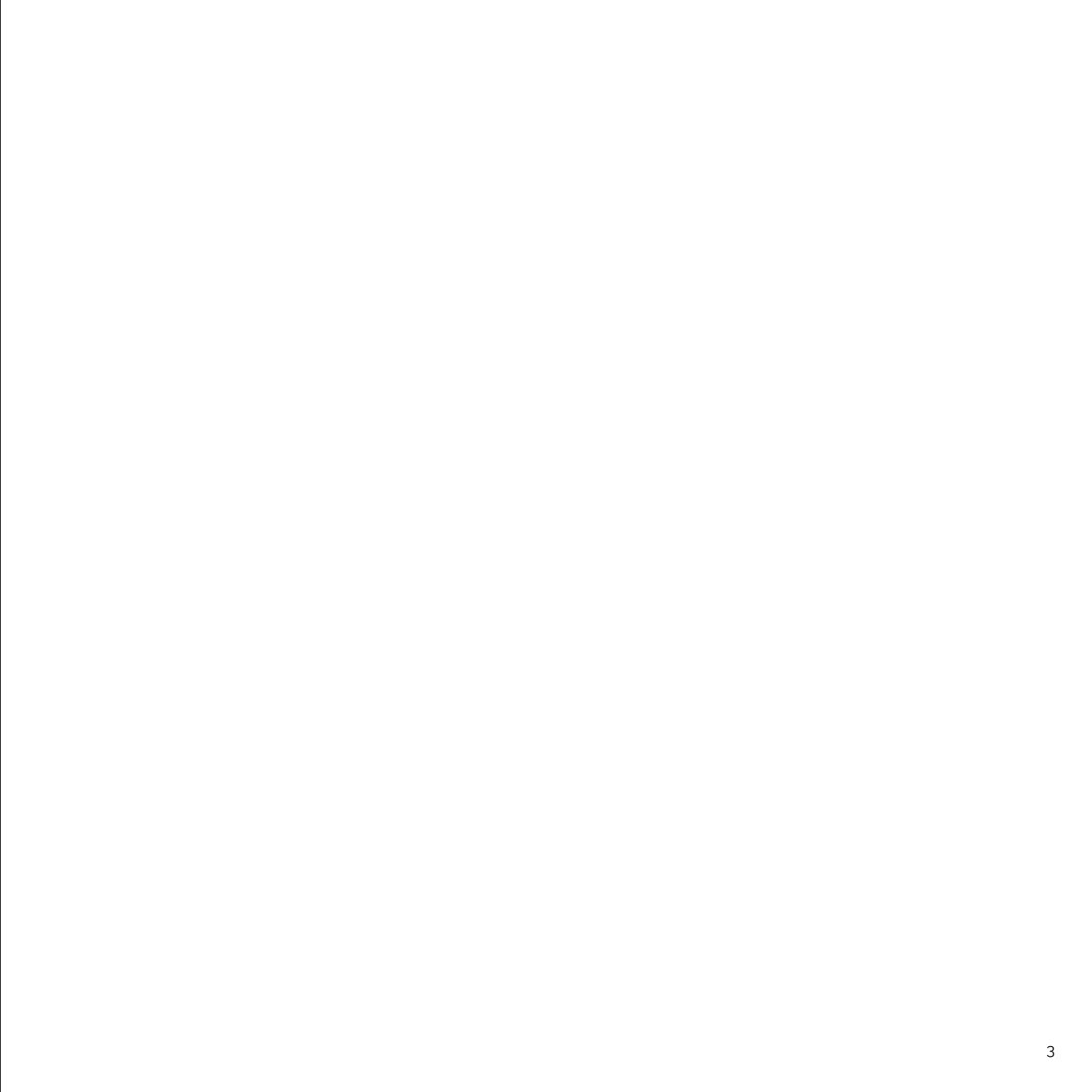

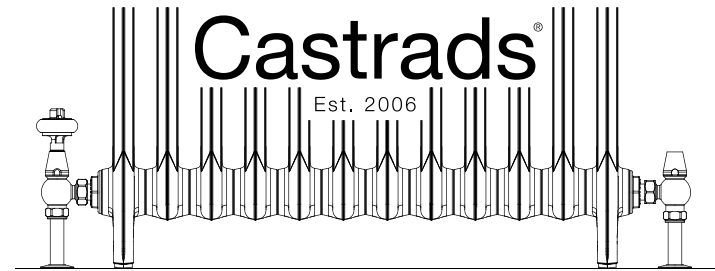

Custom Radiators, Unique Homes

Brooklyn | Manhattan | London | Manchester



Mercury 3 Column 26in. 12 sections in Paint & Paper Library Plaster V with Windsor Satin Nickel TRV and Whitworth wall stay.

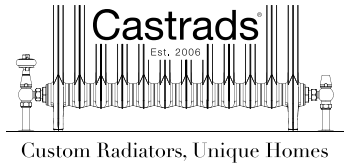

A FRESH APPROACH TO HOME HEATING

Castrads produce beautiful, custom radiators built to your specific requirements. We're a family-run company, manufacturing in Manchester, UK, since 2006. With a lifespan of centuries, our cast iron radiators are sustainability heavyweights. A solid choice for your unique home.



UK
CA



CE

Emmeline | 27in. 10 sections in Chalk with Windsor Polished Brass TRV Whitworth wall stays.



Rococo I 22in. 6 sections in Beaten Brass with Chatsworth Natural Brass TRV.

CONTENTS

CAST IRON RADIATORS	P. 12 - 65
CAST IRON FINISHES	P. 69 - 75
STEEL COLUMN RADIATORS	P. 78- 91
BATHROOM RADIATORS	P. 92 - 105
RADIATOR VALVES	P. 108 - 123
WALL STAYS	P. 124 - 127
HOME CONSULTATION SERVICE	P. 128 - 129
IRONSHIELD WARRANTY	P. 130
EXPLAINERS & MEASURING GUIDES	P. 131 - 142

CAST IRON RADIATORS

Our radiators come fully finished, with US-standard NPT connections. Suitable for one-pipe and two-pipe steam systems, as well as hot water. They can be paired with thermostatic valves for automatic temperature control (see page 106). A carefully curated range of styles, an unrivaled choice of finishes, custom sizing up to 98 in. long. Made to order, built to last.

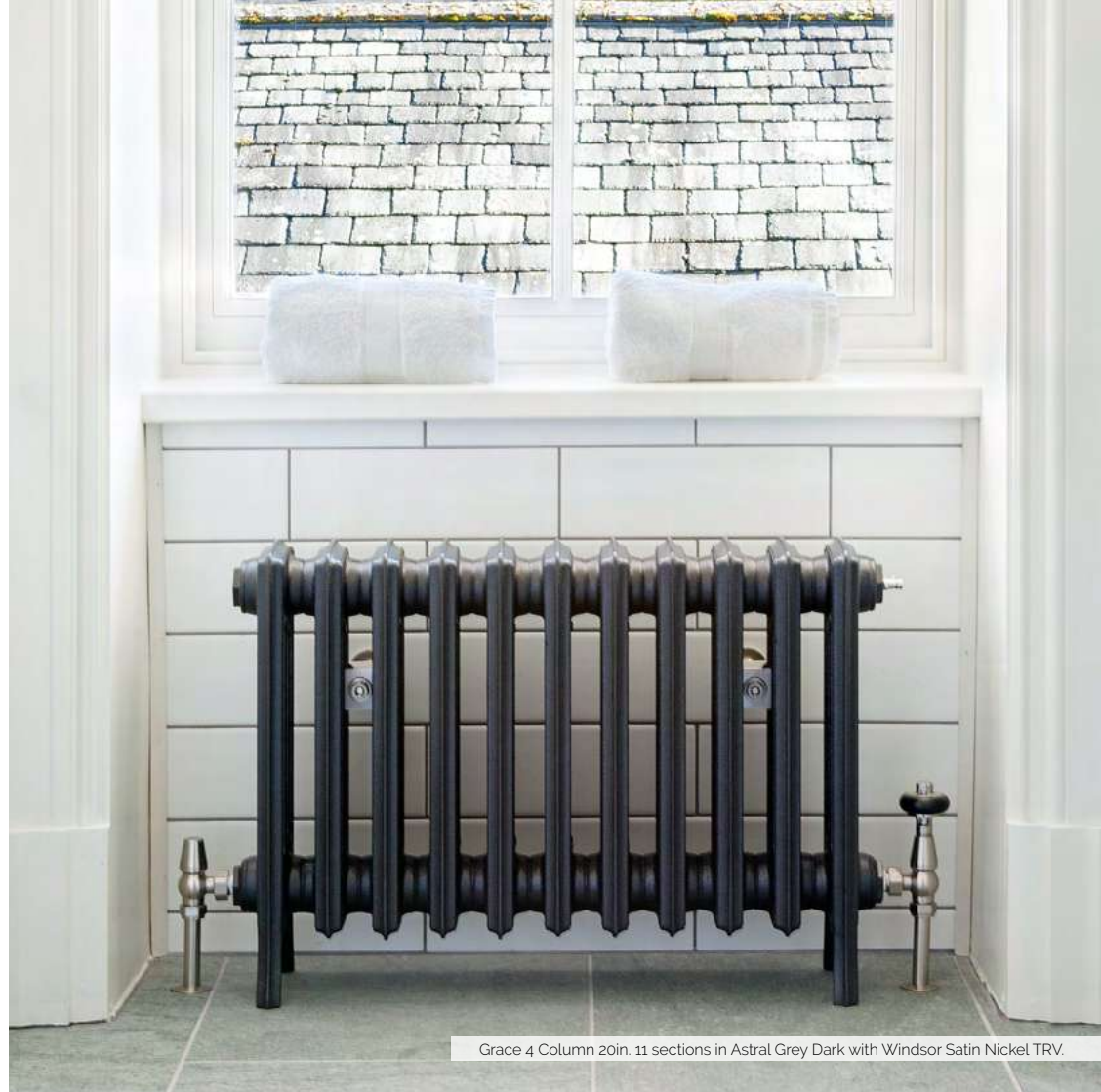

Grace 4 Column 20in. 11 sections in Astral Grey Dark with Windsor Satin Nickel TRV.



MERCURY

A modern column radiator designed by Castrads.



MERCURY

Our most versatile range of cast iron radiators. Delicate V-detailing on crisp columns, elegantly tapered feet and flawlessly blended top curves.

Mercury 2 Column

Available in 3 heights

2.8 in. deep

Mercury 3 Column

Available in 4 heights

4 in. deep

Mercury 4 Column

Available in 6 heights

5.5 in. deep

Mercury 6 Column

Available in 2 heights

8.5 in. deep



Mercury 4 Column 30in. 10 sections in Beaten Brass with Windsor Natural Brass TRR and Whitworth wall stay.



MERCURY 2 COLUMN
the detail

MERCURY 2 COLUMN

Model	S _{Max}	EDR	Output		Dimensions		
			Hot water	Steam	Height	Depth	Length
Mercury 2 Column 18in	18	0.93 sq. ft.	139 BTUs	223 BTUs	18.1 in.	2.8 in.	2.3 in.
Mercury 2 Column 30in	18	1.57 sq. ft.	236 BTUs	377 BTUs	29.9 in.	2.8 in.	2.3 in.
Mercury 2 Column 38in	18	1.98 sq. ft.	297 BTUs	475 BTUs	37.8 in.	2.8 in.	2.3 in.



These models may also be wall mounted. Speak to us about wall-hanging options.
Outputs per section at 170°F (water) and 215°F (steam). Height includes legs. Length is per section.
S_{Max} - Maximum size for delivery in one piece. Available up to 40 sections with partial home assembly.



MERCURY 3 COLUMN
the detail

MERCURY 3 COLUMN

Model	S _{Max}	EDR	Output		Dimensions		
			Hot water	Steam	Height	Depth	Length
Mercury 3 Column 22in	18	1.43 sq. ft.	215 BTUs	343 BTUs	22 in.	4 in.	2.3 in.
Mercury 3 Column 26in	18	1.76 sq. ft.	264 BTUs	422 BTUs	26 in.	4 in.	2.3 in.
Mercury 3 Column 30in	18	2.09 sq. ft.	313 BTUs	502 BTUs	29.9 in.	4 in.	2.3 in.
Mercury 3 Column 34in	18	2.33 sq. ft.	349 BTUs	559 BTUs	33.9 in.	4 in.	2.3 in.



These models may also be wall mounted. Speak to us about wall-hanging options.
Outputs per section at 170°F (water) and 215°F (steam). Height includes legs. Length is per section.
S_{Max} - Maximum size for delivery in one piece. Available up to 40 sections with partial home assembly.



MERCURY 4 COLUMN
the detail

MERCURY 4 COLUMN

Model	S _{Max}	EDR	Output		Dimensions		
			Hot water	Steam	Height	Depth	Length
Mercury 4 Column 14in	18	1.17 sq. ft.	175 BTUs	281 BTUs	14.2 in.	5.5 in.	2.3 in.
Mercury 4 Column 18in	18	1.54 sq. ft.	231 BTUs	370 BTUs	18.1 in.	5.5 in.	2.3 in.
Mercury 4 Column 22in	18	1.85 sq. ft.	277 BTUs	444 BTUs	22 in.	5.5 in.	2.3 in.
Mercury 4 Column 30in	16	2.55 sq. ft.	383 BTUs	612 BTUs	29.9 in.	5.5 in.	2.3 in.
Mercury 4 Column 34in	14	2.91 sq. ft.	436 BTUs	698 BTUs	33.9 in.	5.5 in.	2.3 in.
Mercury 4 Column 38in	14	3.23 sq. ft.	484 BTUs	775 BTUs	37.8 in.	5.5 in.	2.3 in.

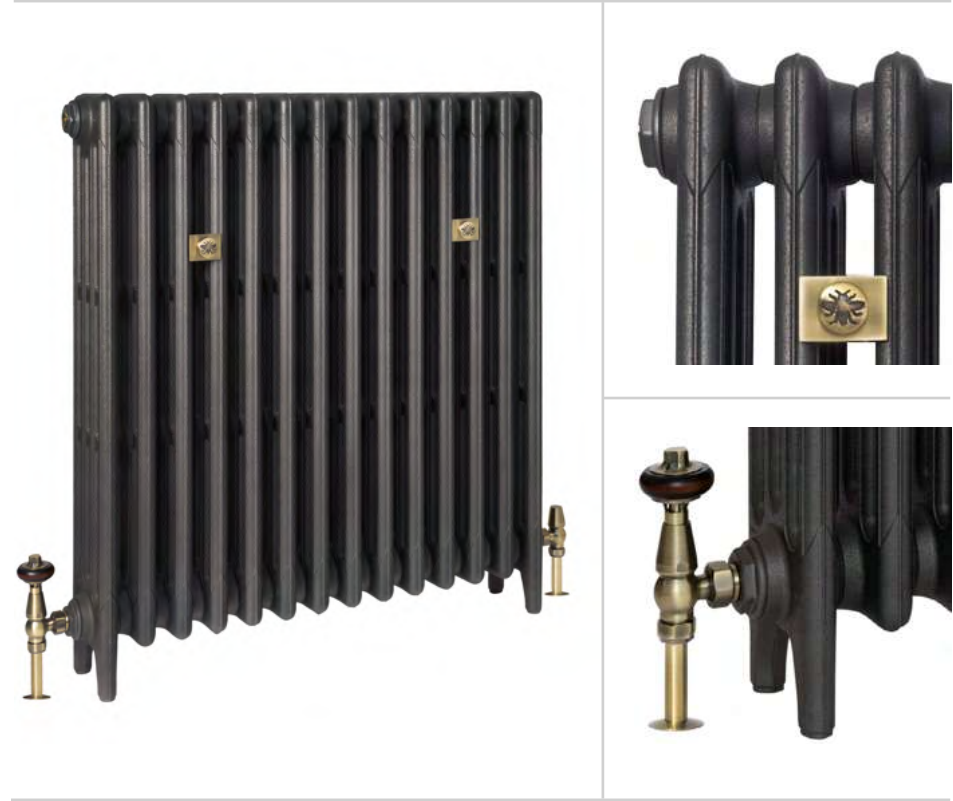

Outputs per section at 170°F (water) and 215°F (steam). Height includes legs. Length is per section.
S_{Max} - Maximum size for delivery in one piece. Available up to 40 sections with partial home assembly.



MERCURY 6 COLUMN
the detail

MERCURY 6 COLUMN

Model	S _{Max}	EDR	Output		Dimensions		
			Hot water	Steam	Height	Depth	Length
Mercury 6 Column 14in	18	1.67 sq. ft.	251 BTUs	401 BTUs	14.2 in.	8.5 in.	2.3 in.
Mercury 6 Column 38in	8	4.62 sq. ft.	693 BTUs	1109 BTUs	37.8 in.	8.5 in.	2.3 in.





GRACE

A distinctive design with crisp, defined lines.



GRACE

A fluted profile and inclined feet with staggered spacing between columns for extra interest.

Grace 2 Column

Available in 4 heights

3.5 in. deep

Grace 4 Column

Available in 5 heights

6.9 in. deep

Grace 6 Column

Available in 4 heights

10 in. deep



Grace 4 Column 20in. 8 sections in Full Polish with Windsor Satin Nickel TRV.



GRACE 2 COLUMN
the detail

GRACE 2 COLUMN

Model	S _{Max}	EDR	Output		Dimensions		
			Hot water	Steam	Height	Depth	Length
Grace 2 Column 19in	18	1.04 sq. ft.	156 BTUs	250 BTUs	18.9 in.	3.5 in.	2.4 in.
Grace 2 Column 25in	18	1.33 sq. ft.	199 BTUs	319 BTUs	25.2 in.	3.5 in.	2.4 in.
Grace 2 Column 29in	18	1.57 sq. ft.	235 BTUs	377 BTUs	29.1 in.	3.5 in.	2.4 in.
Grace 2 Column 41in	18	2.19 sq. ft.	328 BTUs	526 BTUs	40.9 in.	3.5 in.	2.4 in.



These models may also be wall mounted. Speak to us about wall-hanging options.
Outputs per section at 170°F (water) and 215°F (steam). Height includes legs. Length is per section.
S_{Max} - Maximum size for delivery in one piece. Available up to 40 sections with partial home assembly.



GRACE 4 COLUMN
the detail

GRACE 4 COLUMN

Model	S _{Max}	EDR	Output		Dimensions		
			Hot water	Steam	Height	Depth	Length
Grace 4 Column 14in	18	1.17 sq. ft.	175 BTUs	281 BTUs	14.1 in.	6.9 in.	2.4 in.
Grace 4 Column 20in	18	1.73 sq. ft.	259 BTUs	415 BTUs	19.8 in.	6.9 in.	2.4 in.
Grace 4 Column 26in	18	2.26 sq. ft.	339 BTUs	542 BTUs	26.0 in.	6.9 in.	2.4 in.
Grace 4 Column 30in	16	2.59 sq. ft.	389 BTUs	622 BTUs	29.9 in.	6.9 in.	2.4 in.
Grace 4 Column 38in	14	3.41 sq. ft.	512 BTUs	818 BTUs	37.8 in.	6.9 in.	2.4 in.





GRACE 6 COLUMN *the detail*

GRACE 6 COLUMN

Model	S _{Max}	EDR	Output		Dimensions		
			Hot water	Steam	Height	Depth	Length
Grace 6 Column 19in	16	2.37 sq. ft.	356 BTUs	569 BTUs	19.1 in.	10 in.	2.4 in.
Grace 6 Column 26in	12	3.22 sq. ft.	483 BTUs	773 BTUs	26 in.	9.9 in.	2.4 in.
Grace 6 Column 30in	10	3.79 sq. ft.	569 BTUs	910 BTUs	29.9 in.	10 in.	2.4 in.
Grace 6 Column 38in	8	4.71 sq. ft.	706 BTUs	1130 BTUs	37.8 in.	9.8 in.	2.4 in.



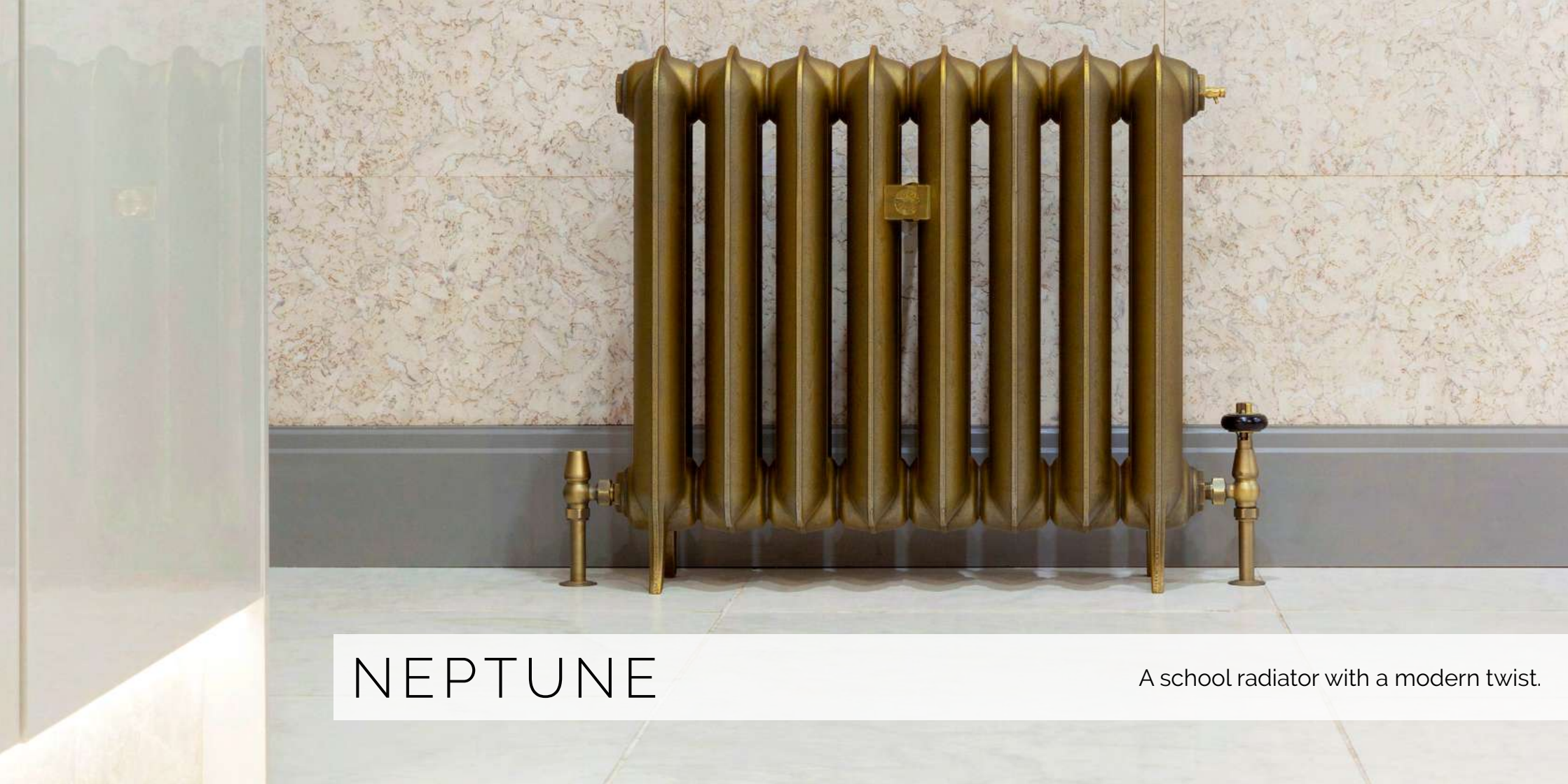

NEPTUNE

A school radiator with a modern twist.



NEPTUNE

Modern curves and a ridged shoulder make Neptune a bold feature in contemporary interiors.

Neptune II

Available in 4 heights

71 in. deep

Neptune III

Available in 4 heights

79 in. deep



Neptune II 20in. in Beaten Brass with Windsor Natural Brass TRV.



NEPTUNE II
the detail

NEPTUNE II

Model	S _{Max}	EDR	Output		Dimensions		
			Hot water	Steam	Height	Depth	Length
Neptune II 20in	14	2.29 sq. ft.	343 BTUs	550 BTUs	20.5 in.	7.1 in.	3.1 in.
Neptune II 24in	12	2.74 sq. ft.	411 BTUs	658 BTUs	24.4 in.	7.1 in.	3.1 in.
Neptune II 28in	10	3.29 sq. ft.	494 BTUs	790 BTUs	28.3 in.	7.1 in.	3.1 in.
Neptune II 36in	9	4.28 sq. ft.	642 BTUs	1027 BTUs	36.2 in.	7.1 in.	3.1 in.



Outputs per section at 170°F (water) and 215°F (steam). Height includes legs. Length is per section.
S_{Max} - Maximum size for delivery in one piece. Available up to 40 sections with partial home assembly.

Above left: Neptune II 28in. in Aged Gold. Top right: Neptune II in Natural Brass.
Bottom right: Neptune II in Natural Pewter.



NEPTUNE III
the detail

NEPTUNE III

Model	S _{Max}	EDR	Output		Dimensions		
			Hot water	Steam	Height	Depth	Length
Neptune III 20in	12	2.61 sq. ft.	391 BTUs	626 BTUs	20.5 in.	7.9 in.	3.1 in.
Neptune III 24in	10	3.17 sq. ft.	475 BTUs	761 BTUs	24.4 in.	7.9 in.	3.1 in.
Neptune III 28in	9	3.66 sq. ft.	549 BTUs	878 BTUs	28.3 in.	7.9 in.	3.2 in.
Neptune III 36in	7	4.68 sq. ft.	702 BTUs	1123 BTUs	36.2 in.	7.9 in.	3.2 in.



Outputs per section at 170°F (water) and 215°F (steam). Height includes legs. Length is per section.
S_{Max} - Maximum size for delivery in one piece. Available up to 40 sections with partial home assembly.

Above left: Neptune III 36in. in Lacquered Iron. Top Right: Neptune III in Lacquered Iron.
Bottom right: Neptune III in Farrow & Ball® Pigeon.



EMMELINE

An updated school radiator designed by Castrads.



EMMELINE

With a scalloped topline, gentle contours and refined feet, Emmeline is our own take on a long-established style.

Emmeline I

Available in 3 heights

4.3in. deep

Emmeline II

Available in 3 heights

6 in. deep

Arriving Summer 2022



Emmeline I 19in. 8 sections in Grey Bronze with Windsor Natural Brass manual valves, and Whitworth wall stay.



EMMELINE I
the detail

EMMELINE I

Model	S _{Max}	EDR	Output		Dimensions		
			Hot water	Steam	Height	Depth	Length
Emmeline I 19in	16	1.20 sq. ft.	180 BTUs	288 BTUs	18.5 in.	4.3 in.	2.6 in.
Emmeline I 27in	16	1.69 sq. ft.	254 BTUs	406 BTUs	26.5 in.	4.3 in.	2.6 in.
Emmeline I 35in	16	2.16 sq. ft.	324 BTUs	518 BTUs	34.5 in.	4.3 in.	2.6 in.



These models may also be wall mounted. Speak to us about wall-hanging options.

Outputs per section at 170°F (water) and 215°F (steam). Height includes legs. Length is per section.

S_{Max} - Maximum size for delivery in one piece. Available up to 40 sections with partial home assembly.



ROCOCO

A statement decorative radiator.



ROCOCO

Featuring an intricate motif of scrolls and flourishes, Rococo is a replica of an original American Radiator Company design.

Rococo I

Available in 3 heights

5.5 in. deep

Rococo II

Available in 4 heights

8.1 to 8.7 in. deep

Rococo III

Available in 3 heights

10.1 in. deep



Rococo III 38in. 8 sections in Satin Polish with Chatsworth Satin Nickel TRV.



ROCOCO I
the detail

ROCOCO I

Model	S _{Max}	EDR	Output		Dimensions		
			Hot water	Steam	Height	Depth	Length
Rococo I 22in	15	1.59 sq. ft.	238 BTUs	382 BTUs	22 in.	5.5 in.	3 in.
Rococo I 26in	14	1.83 sq. ft.	275 BTUs	439 BTUs	26 in.	5.5 in.	3 in.
Rococo I 37in	12	2.78 sq. ft.	417 BTUs	667 BTUs	37.4 in.	5.3 in.	3 in.



These models may also be wall mounted. Speak to us about wall-hanging options.
Outputs per section at 170°F (water) and 215°F (steam). Height includes legs. Length is per section.
S_{Max} - Maximum size for delivery in one piece. Available up to 40 sections with partial home assembly.

Above left: Rococo I 22in. in Astral Grey Mid. Top right: Rococo I in Astral Grey Mid.
Bottom right: Rococo I in Ceramic White.

ROCOCO II
the detail



ROCOCO II

Model	S _{Max}	EDR	Output		Dimensions		
			Hot water	Steam	Height	Depth	Length
Rococo II 20in	14	2.08 sq. ft.	312 BTUs	499 BTUs	20.1 in.	8.7 in.	3.2 in.
Rococo II 26in	11	2.66 sq. ft.	399 BTUs	638 BTUs	26 in.	8.1 in.	3 in.
Rococo II 30in	11	3.06 sq. ft.	459 BTUs	734 BTUs	29.9 in.	8.5 in.	3.1 in.
Rococo II 37in	8	3.75 sq. ft.	562 BTUs	900 BTUs	37.4 in.	8.1 in.	3 in.





ROCOCO III
the detail

ROCOCO III

Model	S _{Max}	EDR	Output		Dimensions		
			Hot water	Steam	Height	Depth	Length
Rococo III 19in	13	2.19 sq. ft.	329 BTUs	526 BTUs	18.4 in.	10.1 in.	3.1 in.
Rococo III 30in	10	3.73 sq. ft.	559 BTUs	895 BTUs	30.2 in.	10.1 in.	3 in.
Rococo III 38in	7	4.61 sq. ft.	691 BTUs	1106 BTUs	38 in.	10.1 in.	3 in.



Outputs per section at 170°F (water) and 215°F (steam). Height includes legs. Length is per section.
S_{Max} - Maximum size for delivery in one piece. Available up to 40 sections with partial home assembly.



VULCAN

A pared back wall-hung radiator.





VULCAN

Simple Bauhaus geometry with understated styling for a strong modernist statement.

Vulcan III

Available in 3 heights

3.6 to 3.9 in. deep

Wall-hung model





VULCAN III
the detail

VULCAN III

Model	S _{Max}	EDR	Output		Dimensions		
			Hot water	Steam	Height	Depth	Length
Vulcan III 17in	18	1.52 sq. ft.	228 BTUs	365 BTUs	16.8 in.	3.9 in.	2.4 in.
Vulcan III 23in	18	1.97 sq. ft.	295 BTUs	473 BTUs	22.7 in.	3.9 in.	2.4 in.
Vulcan III 27in	18	2.27 sq. ft.	341 BTUs	545 BTUs	27.3 in.	3.6 in.	2.4 in.



This model is wall-hung and must be mounted on a suitably strong substrate.
Outputs per section at 170°F (water) and 215°F (steam). Length is per section.
S_{Max} - Maximum size for delivery in one piece. Available up to 40 sections with partial home assembly.

Above left and right: Vulcan III 27in. 10 Sections in Etch-coated Polish.
Bottom right: Vulcan III 17in. 10 sections in Black Iron.



Mercury 4 Column 30in. in Astral Grey Mid with Whitworth Chrome wall stay.



CAST IRON FINISHES

Get the perfect finish for your interior.

Choose from our Signature collection, specialist Bare Metal finishes or custom colors from Farrow & Ball® and Benjamin Moore®.

Can't see the finish you want? Just get in touch.



Grace 6 Column 38in. 8 sections in Farrow & Ball® Off Black with Windsor Natural Brass Corner TRV.

BARE METAL

Bare Metal finishes are achieved with polish and lacquer. They're hand applied with natural variation from one piece to the next.



Mirror Polish



Full Polish



Satin Polish



Etch-coated Polish



Aged Gold



Natural Brass



Beaten Brass



Bronze



Natural Pewter



Ox Blood



Sapphire Blue



Wimbledon Green

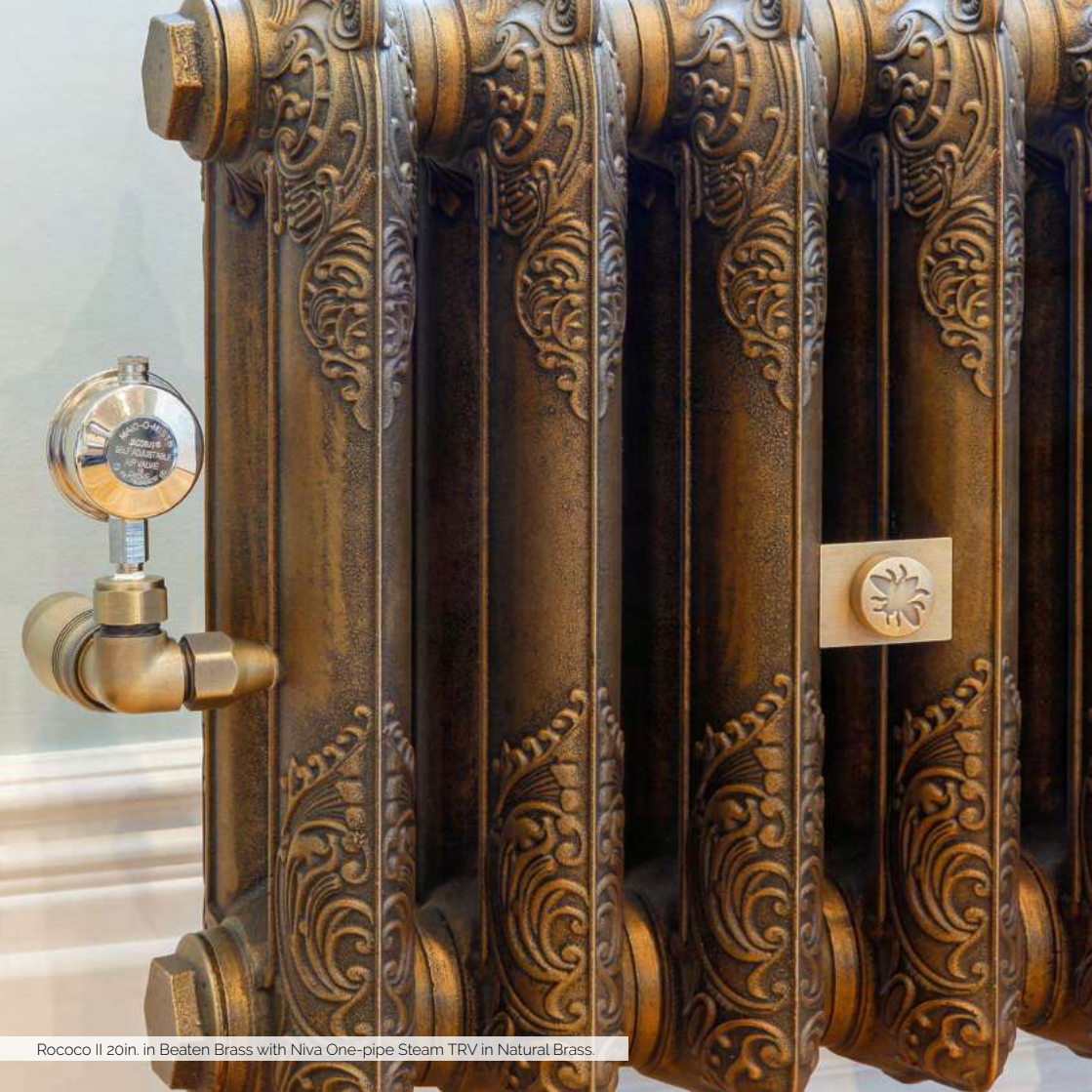

Rococo II zoin. in Beaten Brass with Niva One-pipe Steam TRV in Natural Brass.



Mercury 4 Column 18in. in Astral Grey Mid with Natural Brass One-pipe Steam TRV.

SIGNATURE

Our core range of popular finishes, developed especially for cast iron.



Bright White



Ceramic White



Chalk



Grey Bronze



Manhattan



Astral Grey Mid



Astral Grey Dark



Iron Grey



Midnight Ink



Anthracite



Black Iron



Matt Black



Mercury 4 Column 22in. in Little Greene® Citrine with Windsor Satin Nickel TRV and Whitworth wall stays.

MAKE IT A MATCH

For a seamless drench or a vibrant pop, choose your colors from our favorite paint collections.

We use genuine branded paints under license from the manufacturers.



Little Greene®
— PAINT & PAPER 1773 —



FARROW & BALL
CRAFTSMEN IN PAINT AND PAPER



Benjamin Moore®



Mercury 3 Column 34in. in Paint & Paper Library Plaster V with Windsor Satin Nickel TRV and Whitworth wall stays.

STEEL RADIATORS

Extremely versatile bespoke steel column radiators. Built to your requirements up to 98in. tall, 79in. long and available in five depths. Steel multicolumn radiators are suitable for closed-loop hydronic systems but not steam or open-vented hydronic systems.



Florence 3 Column 47in. in Bright White with Windsor Satin Nickel TRV.



FLORENCE

Italian-made column radiators tailored to fit any space.



FLORENCE

An extensive range of sizes which can be either wall-hung or floor-mounted. Powder coated in any of our finishes from our Signature collection and over 180 RAL colors.

Florence 2 Column **Florence 3 Column** **Florence 4 Column** **Florence 5 Column** **Florence 6 Column**

Available in 15 heights

Available in 15 heights

Available in 15 heights

Available in 15 heights

Available in 15 heights

2.6 in. deep

4 in. deep

5.5 in. deep

7 in. deep

8.5 in. deep



FLORENCE 2 COLUMN

Model	Panel height	Section heat output (170°F)
Florence 2 Column 8in	7.6 in.	60 BTUs
Florence 2 Column 12in	11.9 in.	92 BTUs
Florence 2 Column 16in	15.8 in.	120 BTUs
Florence 2 Column 20in	19.8 in.	148 BTUs
Florence 2 Column 24in	23.7 in.	172 BTUs
Florence 2 Column 27in	27.0 in.	196 BTUs
Florence 2 Column 30in	30.2 in.	216 BTUs
Florence 2 Column 36in	35.5 in.	253 BTUs
Florence 2 Column 39in	39.4 in.	277 BTUs
Florence 2 Column 47in	47.3 in.	334 BTUs
Florence 2 Column 59in	59.1 in.	415 BTUs
Florence 2 Column 71in	70.9 in.	500 BTUs
Florence 2 Column 79in	78.8 in.	559 BTUs
Florence 2 Column 87in	86.7 in.	619 BTUs
Florence 2 Column 99in	98.5 in.	710 BTUs



FLORENCE 3 COLUMN

Model	Panel height	Section heat output (170°F)
Florence 3 Column 8in	7.6 in.	80 BTUs
Florence 3 Column 12in	11.9 in.	132 BTUs
Florence 3 Column 16in	15.8 in.	168 BTUs
Florence 3 Column 20in	19.8 in.	204 BTUs
Florence 3 Column 24in	23.7 in.	244 BTUs
Florence 3 Column 27in	27.0 in.	273 BTUs
Florence 3 Column 30in	30.2 in.	305 BTUs
Florence 3 Column 36in	35.5 in.	354 BTUs
Florence 3 Column 39in	39.4 in.	390 BTUs
Florence 3 Column 47in	47.3 in.	463 BTUs
Florence 3 Column 59in	59.1 in.	572 BTUs
Florence 3 Column 71in	70.9 in.	681 BTUs
Florence 3 Column 79in	78.8 in.	752 BTUs
Florence 3 Column 87in	86.7 in.	828 BTUs
Florence 3 Column 99in	98.5 in.	939 BTUs



FLORENCE 4 COLUMN

Model	Panel height	Section heat output (170°F)
Florence 4 Column 8in	7.6 in.	105 BTUs
Florence 4 Column 12in	11.9 in.	168 BTUs
Florence 4 Column 16in	15.8 in.	221 BTUs
Florence 4 Column 20in	19.8 in.	269 BTUs
Florence 4 Column 24in	23.7 in.	317 BTUs
Florence 4 Column 27in	27.0 in.	358 BTUs
Florence 4 Column 30in	30.2 in.	399 BTUs
Florence 4 Column 36in	35.5 in.	460 BTUs
Florence 4 Column 39in	39.4 in.	508 BTUs
Florence 4 Column 47in	47.3 in.	601 BTUs
Florence 4 Column 59in	59.1 in.	737 BTUs
Florence 4 Column 71in	70.9 in.	870 BTUs
Florence 4 Column 79in	78.8 in.	958 BTUs
Florence 4 Column 87in	86.7 in.	1046 BTUs
Florence 4 Column 99in	98.5 in.	1177 BTUs



FLORENCE 5 COLUMN

Model	Panel height	Section heat output (170°F)
Florence 5 Column 8in	7.6 in.	129 BTUs
Florence 5 Column 12in	11.9 in.	204 BTUs
Florence 5 Column 16in	15.8 in.	269 BTUs
Florence 5 Column 20in	19.8 in.	325 BTUs
Florence 5 Column 24in	23.7 in.	387 BTUs
Florence 5 Column 27in	27.0 in.	436 BTUs
Florence 5 Column 30in	30.2 in.	485 BTUs
Florence 5 Column 36in	35.5 in.	563 BTUs
Florence 5 Column 39in	39.4 in.	615 BTUs
Florence 5 Column 47in	47.3 in.	728 BTUs
Florence 5 Column 59in	59.1 in.	891 BTUs
Florence 5 Column 71in	70.9 in.	1052 BTUs
Florence 5 Column 79in	78.8 in.	1160 BTUs
Florence 5 Column 87in	86.7 in.	1268 BTUs
Florence 5 Column 99in	98.5 in.	1428 BTUs



FLORENCE
the detail

FLORENCE 6 COLUMN

Model	Panel height	Section heat output (170°F)
Florence 6 Column 8in	7.6 in.	150 BTUs
Florence 6 Column 12in	11.9 in.	245 BTUs
Florence 6 Column 16in	15.8 in.	318 BTUs
Florence 6 Column 20in	19.8 in.	387 BTUs
Florence 6 Column 24in	23.7 in.	456 BTUs
Florence 6 Column 27in	27.0 in.	514 BTUs
Florence 6 Column 30in	30.2 in.	567 BTUs
Florence 6 Column 36in	35.5 in.	662 BTUs
Florence 6 Column 39in	39.4 in.	727 BTUs
Florence 6 Column 47in	47.3 in.	855 BTUs
Florence 6 Column 59in	59.1 in.	1046 BTUs
Florence 6 Column 71in	70.9 in.	1238 BTUs
Florence 6 Column 79in	78.8 in.	1362 BTUs
Florence 6 Column 87in	86.7 in.	1487 BTUs
Florence 6 Column 99in	98.5 in.	1675 BTUs



Above left: Florence 5 Column 40in. in RAL 9003. Top right: Florence 3 Column.
Bottom right: Florence 6 Column.

FLORENCE FINISHES

Florence radiators are available in our Signature collection of finishes, selected Bare Metal finishes and over one hundred and eighty RAL colors. Florence finishes are powder coated on smooth steel. They are glossier than on cast iron models and may be slightly different in hue.



SPECIALIST FINISHES



BATHROOM RADIATORS

Our heating options for the bathroom are practical while also adding interest. For more detail on valves and the benefits of thermostatic controls see the explainers at the back of this brochure. Made in Europe with our ten-year Ironshield Warranty.



Vivien 8 towel radiator.



VIVIEN

A traditional style bathroom radiator.



VIVIEN

An Italian-made steel radiator with integrated chrome hanging bar. All radiator inserts are powder-coated in Traffic White (RAL 9016).

Vivien Shallow

Available in 3 widths

6.4 in. deep

Vivien

Available in 3 widths

9.4 in. deep

Vivien 6

1 size only

9.4 in. deep

Vivien 8 Wall Mounted

1 size only

9.4 in. deep



Vivien 5 shallow profile towel radiator.



VIVIEN
the detail

VIVIEN

Model	Output		Dimensions		
	EDR	Hot water	Height	Depth	Width
Vivien 5	10.5 sq.ft.	1574 BTUs	37.5 in.	9.4 in.	19.9 in.
Vivien 5 Shallow Profile	10.5 sq.ft.	1574 BTUs	37.5 in.	6.4 in.	19.9 in.
Vivien 6	19.5 sq.ft.	2923 BTUs	59.8 in.	22.9 in.	
Vivien 8	14.8 sq.ft.	2224 BTUs	37.9 in.	9.4 in.	26.9 in.
Vivien 8 Shallow Profile	14.8 sq.ft.	2224 BTUs	37.9 in.	6.4 in.	26.9 in.
Vivien 8 Wall Mounted	14.8 sq.ft.	2224 BTUs	32.9 in.	9.4 in.	26.9 in.
Vivien 11	18.8 sq.ft.	2827 BTUs	37.9 in.	9.4 in.	31.9 in.
Vivien 11 Shallow Profile	18.8 sq.ft.	2827 BTUs	37.9 in.	6.4 in.	31.9 in.



Above left: Vivien 8 Wall Mounted. Top right: Vivien 6.
Bottom right: Vivien 5.



ELARA

A simple chrome towel warmer.



ELARA

Wall mounted for space saving, Elara can be used in combination with regular radiators for toasty towels and a boost of heat, or alone in smaller bathrooms and ensuites.

Elara

Available in 5 heights

4.9 in. deep

Available in chrome and polished or brushed brass



Elara 5 in Chrome.



ELARA
the detail

ELARA

Model	Output	Height	Dimensions	
			Depth	Width
Elara 2	296 BTUs	10.1 in.	4.9 in.	19.8 in.
Elara 3	388 BTUs	17.3 in.	4.9 in.	19.8 in.
Elara 4	477 BTUs	24.5 in.	4.9 in.	19.8 in.
Elara 5	573 BTUs	31.6 in.	4.9 in.	19.8 in.
Elara 6	675 BTUs	38.8 in.	4.9 in.	19.8 in.



Above left: Elara 5 in Chrome. Top right: Elara 3.
Bottom right: Elara 3.

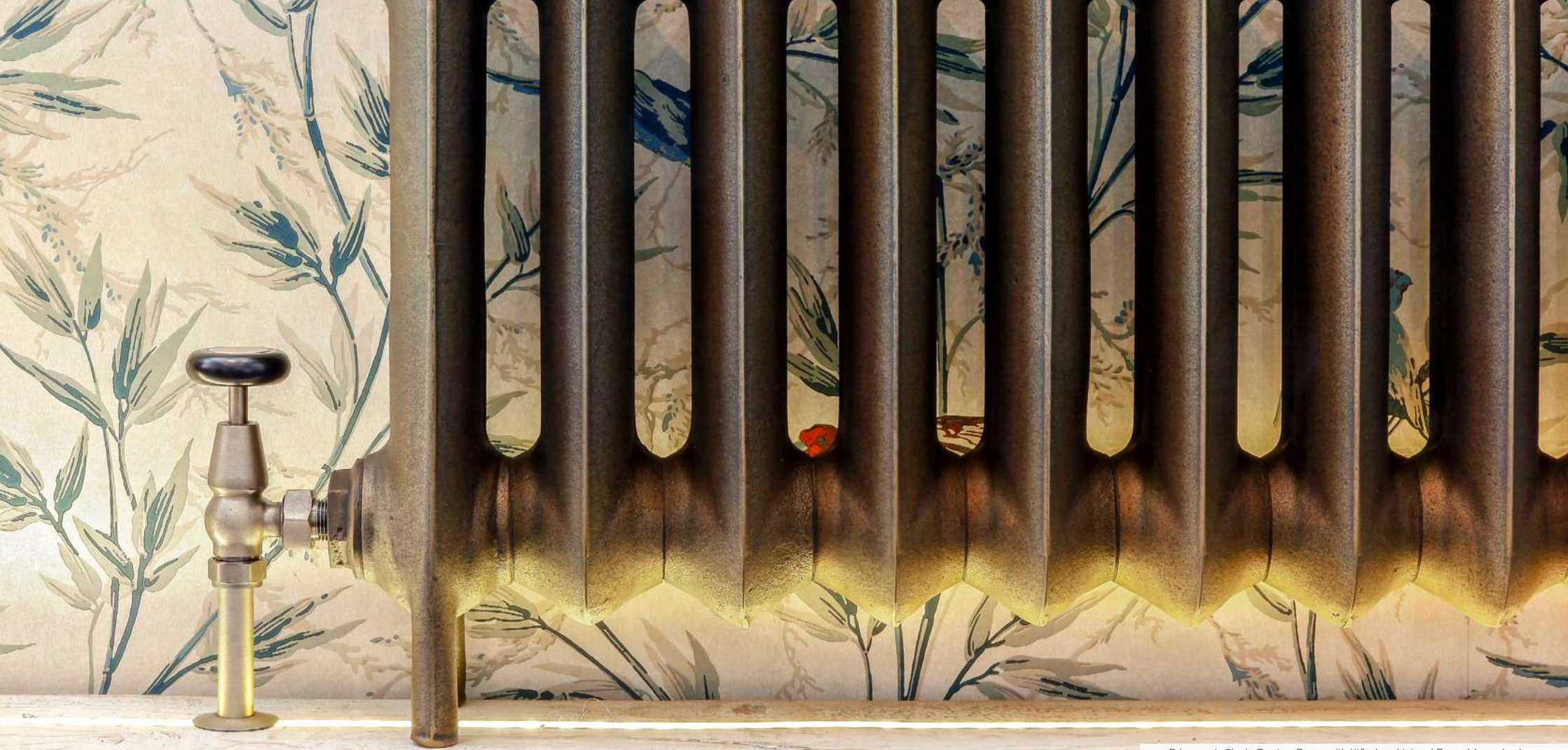

Princess I 18in. in Beaten Brass with Windsor Natural Brass Manual valves.

RADIATOR VALVES

Precision-engineered valves in a range of styles and finishes to complement your radiator. For more detail on valves and the benefits of thermostatic controls see the explainers at the back of this brochure.



Rococo II 26in. in Etch-coated Polish with Windsor Satin Nickel TRV.

WINDSOR

Forged from solid brass and topped with a lacquered hardwood handle with four finishes to choose from.



Windsor valves are made for hydronic systems (see overleaf for steam) and come as a pair, with control valve and lockshield included. All are ½" NPT to ½" compression.



WINDSOR HYDRONIC

Available in corner and angled configurations with either thermostatic or manual control.

All valves are guaranteed for 10 years.

Available in 4 different metal finishes

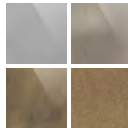

WINDSOR FIP



Designed specifically for large-bore installations, Windsor FIP features a triple-sealed stem and failsafe double-seal plunger with the same solid brass construction and hardwood handle as our Windsor valves.



WINDSOR FIP

Suitable for one-pipe and two-pipe steam as well as hydronic systems.

Three size options (0.75 in., 1 in. and 1.25 in.) with NPT to FIP threaded fitting.

Available both as angled globe and straight gate valves.

Designed in-house and exclusive to Castrads.

Available in 3 different metal finishes

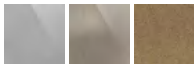

Rococo II 20in. in Beaten Brass with Windsor FIP 1.25in. Natural Brass.

NIVA



Understated and contemporary with an easy-to-use five-point temperature scale. Available in four finishes.



NIVA HYDRONIC & TWO-PIPE STEAM

½" and ¾" NPT to FIP (Hydronic or two-pipe steam).

Five-year Ironshield Warranty.

Control valve and lockshield sold separately.

Available in 4 different metal finishes

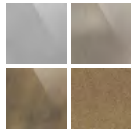

0.75 in. Niva Angled Control Valve and Thermostatic Head with Lockshield in Natural Brass.

NIVA ONE-PIPE STEAM TRV

Our Niva Steam TRV enables localized temperature control for one-pipe steam radiators.

Sensors inside the valve automatically turn the radiator off when the room gets too hot, and turn it back on again when the room cools, maintaining a comfortable ambient temperature.

Thermostatic valves also save money and reduce carbon emissions.



NIVA ONE-PIPE STEAM TRV

½" NPT connections.

Five-year Ironshield Warranty.

May be installed on either side of the radiator.

Ideal with Windsor XL valves on one-pipe systems.

Available in 3 different metal finishes

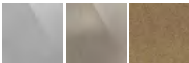

Rococo | 37in. in Natural Pewter with Niva Chrome One-Pipe Steam TRV.

CROSSHEADS

Engineered from solid brass and available in chrome.

Valves that will fit not only our cast iron radiators but also towel rails and more contemporary radiators too.



Crossheads

0.5in. NPT connections.

Manual angled valve.

Five-year Ironshield Warranty.

Identical valve pair.

Available in Chrome



BLEED VALVES

Included as standard on Castrads hydronic radiators or sold separately for refurbishment projects.



BV-A-01-05
1/2" recessed model
Standard fitting
Available in brass and nickel



CBV-0125
1/8" traditional model
Available on request
Available in brass and nickel



CBV-025
1/4" traditional model
Ideal for refurbishments
Available in brass and nickel



VACUUM BREAKERS



Included as standard on Castrads steam radiators.
A necessary addition when upgrading an existing steam radiator to thermostatic control.

An innovative design that ensures thermostatically-controlled steam radiators work to their best ability.



VAB-05
½" recessed design
Neatly sits within radiator
Available in brass and nickel

Two-part body made from precision-milled brass.
Spring operation allows installation in any orientation.

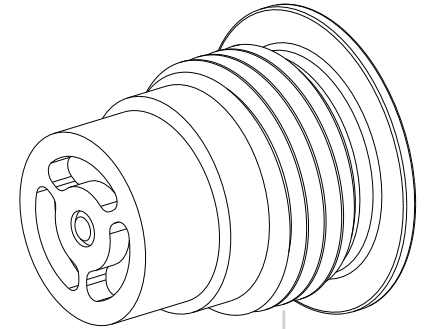
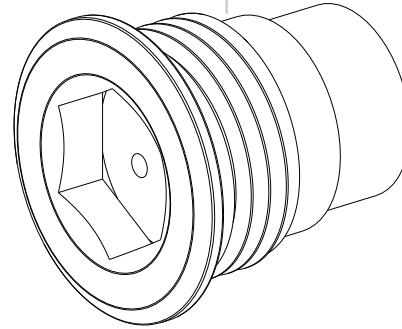

½" thread for maximum compatibility.
Pre-installed seal minimises fitting times.
Discrete design that's recessed into the radiator bushing.

SHROUDS & ESCUTCHEONS

Shrouds available at 5 and 12 inches long. For use with half-inch pipe only.



Antique Brass



Natural Brass



Satin Nickel



Chrome

WHITWORTH WALL STAYS

Solid brass fixings to secure the radiator to the wall. Designed in-house and exclusive to Castrads, the Whitworth features the iconic worker bee motif that symbolizes Manchester's industrial heritage.



Antique Brass



Natural Brass



Satin Nickel



Chrome

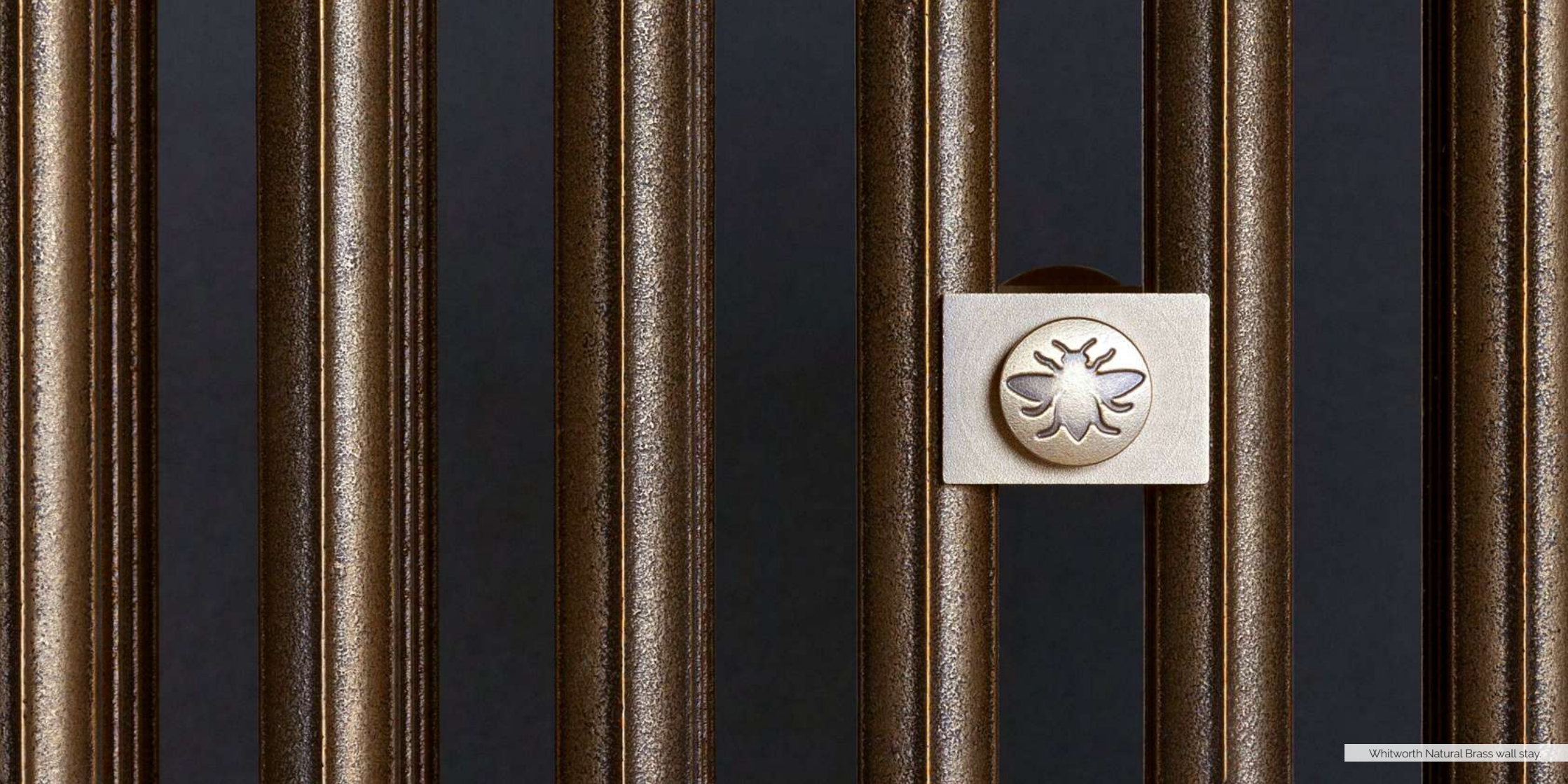



AT-HOME CONSULTATIONS

We offer home visits for advice on sizing, placement and design within New York City



We perform heat loss surveys to ensure you get the right amount of heat.

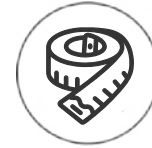

We suggest the most appropriate size and placement of your new radiators.



We offer advice on design and finish to work with your property's aesthetic.

We now offer free virtual consultations. Get in touch to book a convenient time.

(917) 599-9951 | nyc@castrads.com





IRONSHIELD WARRANTY

Your cast iron radiator is a lifetime investment. It should work flawlessly from the moment it's installed.

We Guarantee, No Questions Asked

That's why we take the utmost care to deliver a product that will heat your home for decades to come.

However, if something does go wrong with your product, our Ironshield Warranty (ten years as standard) means that we'll do everything in our power to get you back up and running as quickly as possible.

We won't ask you about water pH levels. We won't ask you to flush your central heating system with chemicals. We will just fix it. And if our engineer can't fix it, we'll replace it.



EXPLAINERS

A brief guide: HYDRONIC VALVES



Hot water enters the radiator through a **control valve** and exits through a **lockshield**. Air is vented through the **bleed valve** to ensure the radiator is completely full of water.

The control valve may be manual or thermostatic. A **thermostatic radiator valve** adds **comfort** and **control**. The modern **energy efficiency** of TRVs can give a **dramatic saving on fuel bills**.

The **lockshield** is used to balance the system, ensuring the radiator furthest from the boiler reaches the same temperature as the one closest to it.

All our hydronic radiators are supplied with a **bleed valve included** as standard. We also stock bleed valves for use in restoration projects.

HYDRONIC (HOT WATER)

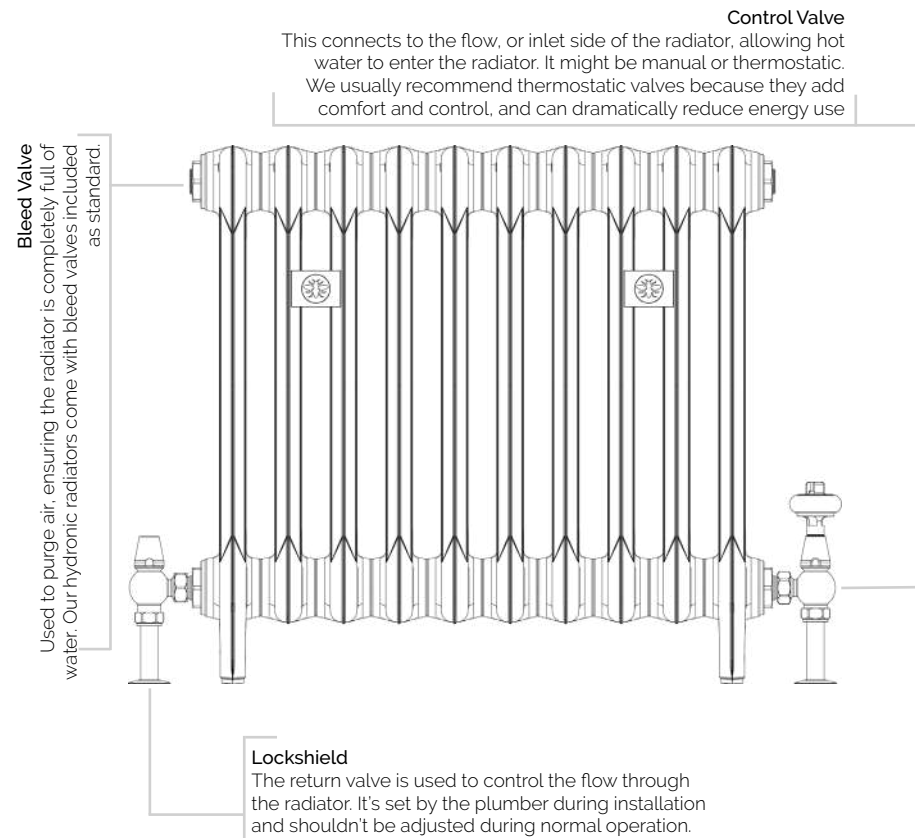

A brief guide: ONE-PIPE STEAM VALVES



Steam enters the radiator through a large-diameter **control valve**, causing the air in the radiator to exit through an **air vent**. The air vent closes automatically when the radiator is full of steam. The steam then cools and condenses, turning back to water. The water returns to the boiler through the same control valve.

The **control valve** must have a large internal bore: Minimum of 1 in. for radiators of 5000 BTUs or fewer, at least 1.25 in. above that.

The heat from a single-pipe steam radiator is controlled by restricting the air that can exit. Adding a **thermostatic valve** (see Nival) adds control and comfort.

Thermostatically-controlled steam radiators require a **vacuum breaker** to ensure the condensate can always return to the boiler. Ours are **supplied with one as standard**.

ONE-PIPE STEAM

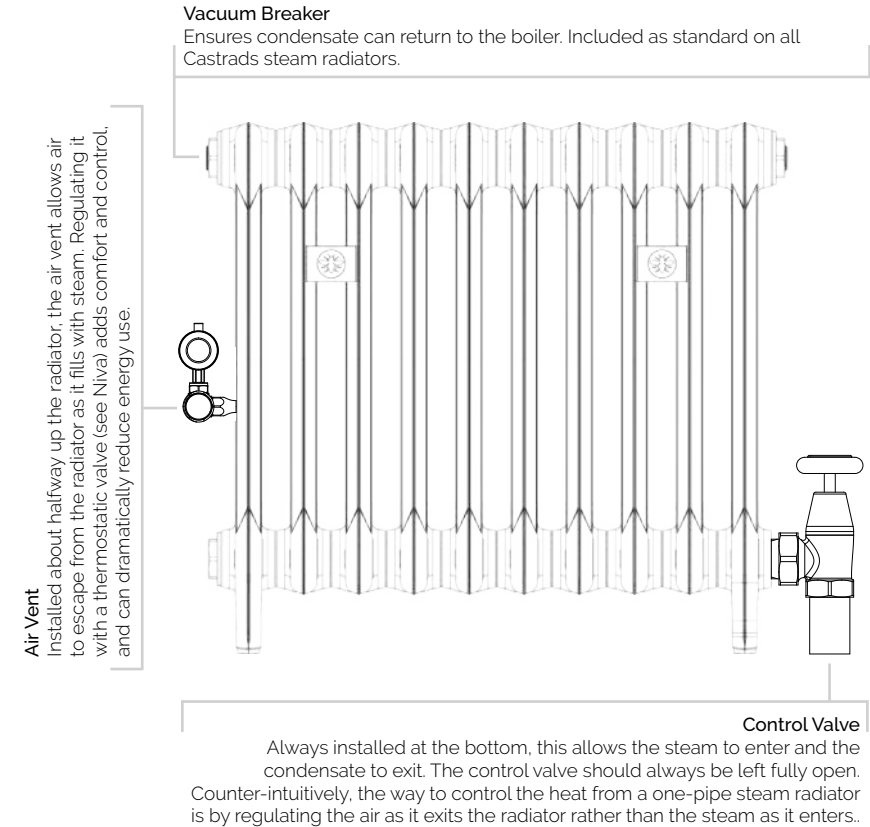

A brief guide: TWO-PIPE STEAM VALVES



Steam enters the radiator through a **control valve**. A **steam trap** allows air and water to exit, returning toward the boiler, but ensures that steam stays trapped inside the radiator.

Air is vented out of the pipes through a master vent, usually near the boiler, before the condensate flows back into the boiler to repeat the process.

The control valve may be manual or thermostatic. A **thermostatic radiator valve** adds **comfort** and **control**. The modern **energy efficiency** of TRVs can give a **dramatic saving** on fuel bills.

Thermostatically-controlled steam radiators require a **vacuum breaker** to ensure the condensate can always return to the boiler. Ours are **supplied with one as standard**.

TWO-PIPE STEAM

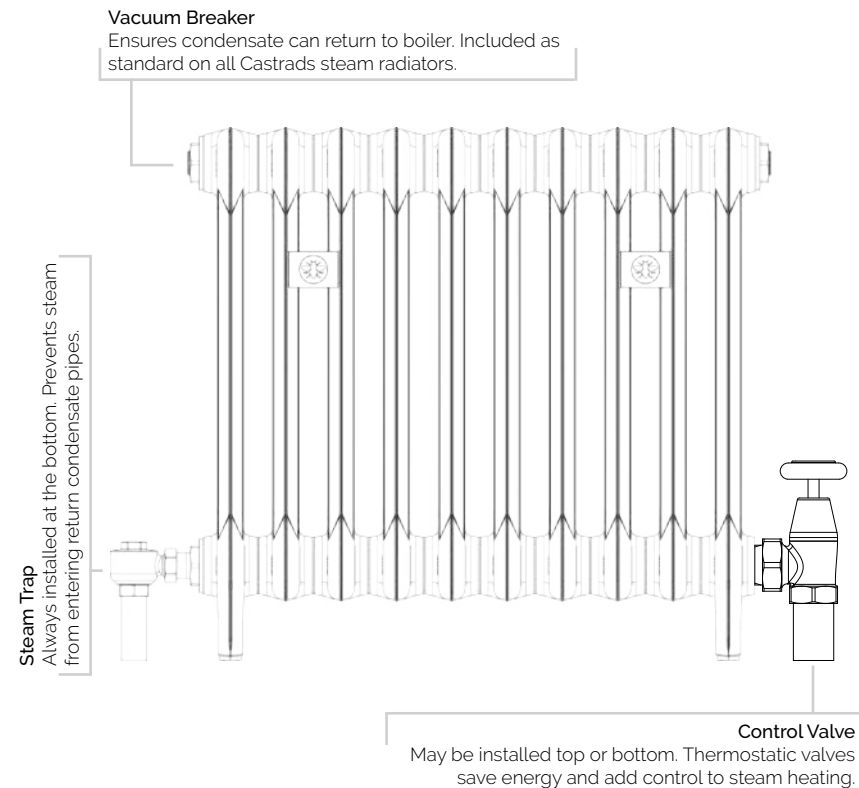

THERMOSTATIC VALVES

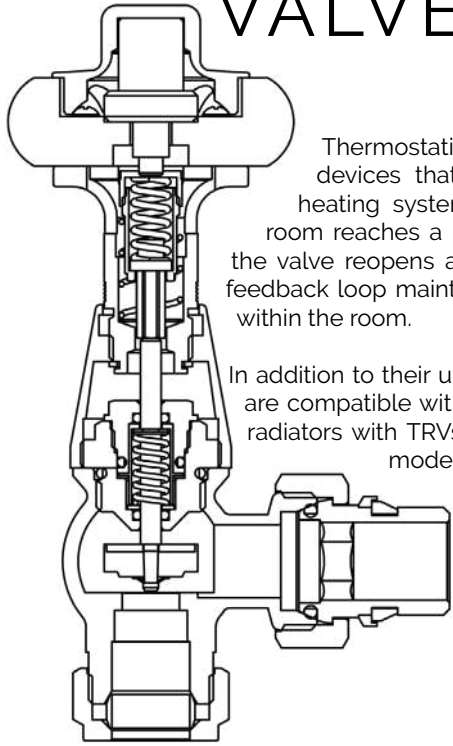

Thermostatic radiator valves, or TRVs, are self-regulating devices that control individual radiators on a central heating system. A TRV turns the radiator off when the room reaches a preset temperature. When the room cools, the valve reopens and the radiator begins heating again. This feedback loop maintains a stable and controllable temperature within the room.

In addition to their unbeatable lifespan, all our cast-iron models are compatible with renewable energy sources, so fitting your radiators with TRVs makes them suitable for any sustainable, modern heating system.

TRVs can be used in every room, however we may recommend using manual valves in certain situations, our representatives will advise accordingly.



Rococo II 30in. in Bronze with Natural Brass Windsor TRV.

RADIATORS UNDER WINDOWS A PERFECT PAIRING

Using the space below your windows creates a 'frame' for your radiator while also boosting its performance. Draughts from the window are eliminated and the room is heated more evenly.

MEASURING UP

Aim for a minimum of 100mm between the top of the radiator and the bottom of the sill. More is fine. Less than that and the radiator begins to look a little cramped.

Match the width of the radiator to the width of the window. If it's a lot bigger it can look imbalanced and if it's a lot smaller it won't counteract the cool draught.

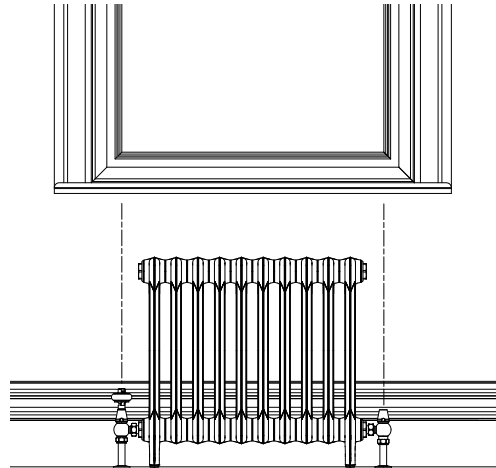

Mercury 4 Column 30in. in Matt Black with Satin Nickel Windsor TRV and Whitworth wall stays.

MEASURING FOR RADIATORS IN BAY WINDOWS

For a single radiator in a bay window, ensure that the valves don't exceed the corners of the bay (see dashed lines on the diagram).

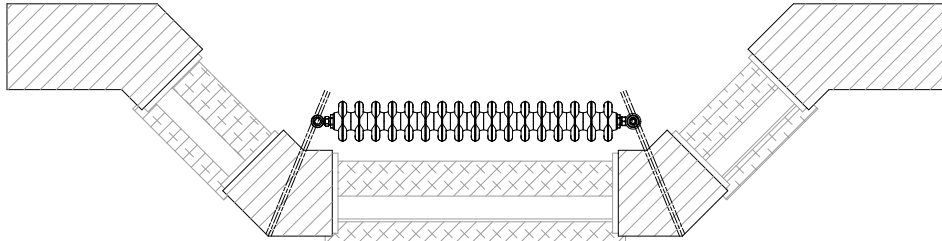

For multiple radiators in a bay, keep each radiator (including valves) to within the width of the window reveal/frame.

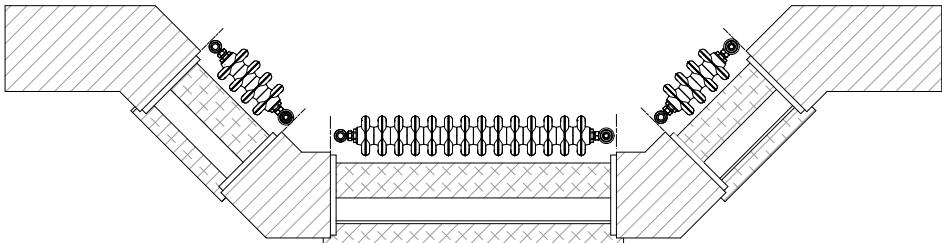

HOT MESS? WE CAN FIX THAT.



Cast iron radiators last not decades but centuries.

If your original radiators are looking run down, our refurbishment service can give them a new lease of life.

With new valves and accessories you can revive yours for the next 100 years.

CALL FOR A REFURBISHMENT QUOTE

VISIT A SHOWROOM

Brooklyn Army Terminal

140A 58th St
Unit 5N-3
Brooklyn, NY 11220

T: +1 (917) 599-9951
E: nyc@castrads.com

New York Design Center

200 Lexington Avenue
Suite #417A
New York, NY 10016

T: +1 (917) 599-9951
E: nyc@castrads.com

London, UK

247 Fulham Road
London
SW3 6HY

T: +44 (0) 20 3397 7295
E: chelsea@castrads.com

Manchester, UK

1 Kenwood Road
Stockport
SK5 6PH

T: +44 (0) 161 439 9350
E: info@castrads.com

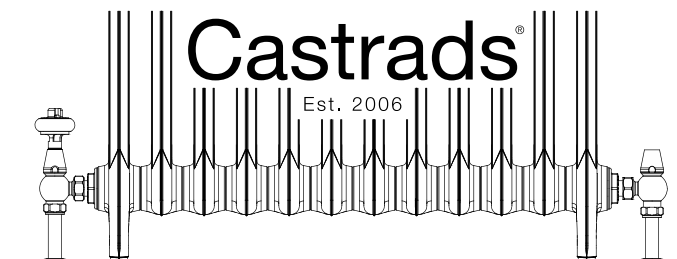

Custom Radiators, Unique Homes

Brooklyn Army Terminal
Building A, Unit 5N-3
140 58th Street
Brooklyn
NY 11220

New York Design Center
Suite #417A
200 Lexington Avenue
New York
NY 10016

(917) 599-9951
www.castrads.com/us

Brooklyn | Manhattan | London | Manchester



